

# CHANNEL VISION™

## 1 Year Limited Warranty

Channel Vision Technology will repair or replace any defect in material or workmanship which occurs during normal use of this product with new or rebuilt parts, free of charge in the USA, for one year from the date of original purchase. This is a no hassle warranty with no mail in warranty card needed. This warranty does not cover damages in shipment, failures caused by other products not supplied by Channel Vision Technology, or failures due to accident, misuse, abuse, acts of God, or alteration of the equipment. This warranty is extended only to the original purchaser when purchased through an authorized reseller. A purchase receipt, invoice, or other proof of original purchase date will be required before warranty repairs are provided.

Mail in service can be obtained during the warranty period by calling (800) 840-0288 toll free. A Return Authorization number must be obtained in advance and can be marked on the outside of the shipping carton.

This warranty gives you specific legal rights and you may have other rights (which vary from state to state). If a problem with this product develops during or after the warranty period, please contact Channel Vision Technology, your dealer or any factory-authorized service center.

Channel Vision products are not intended for use in medical, lifesaving, life sustaining or critical environment applications. Channel Vision customers using or selling Channel Vision products for use in such applications do so at their own risk and agree to fully indemnify Channel Vision for any damages resulting from such improper use or sale.



This device complies with part 15 of the FCC rules.  
Operation is subject to the following two conditions:  
(1) This device may not cause harmful interference, and (2) This device must accept any interference received, including interference that may cause undesired operation.

A-BUS is a registered trademark of LeisureTech Electronics Pty Ltd.  
This product may be covered by one of the following patents:  
US patent no. 7,181,023, 6,389,139 EP 1004222, AU 739808, NZ 502982, Mexico Z41196, Canada CA2301062.

iBus is a registered trademark of Channel Vision Technology.



234 Fischer Avenue Costa Mesa, California 92626 USA  
(714)424-6500 • (800)840-0288 • (714)424-6510 fax

500-326 rev B

# INSTRUCTIONS

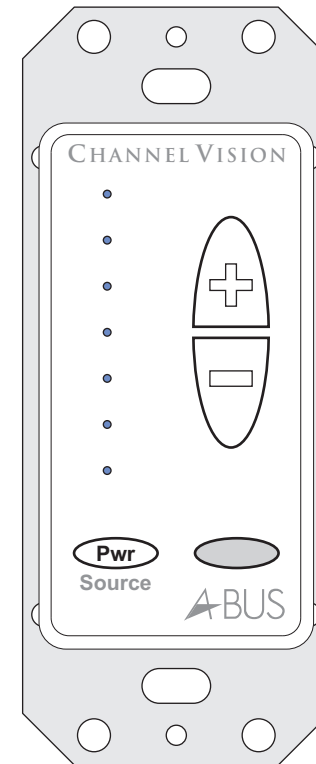

## AB-134 A-BUS® Multi-Source Amplified Keypad

The **AB-134** is an amplified keypad for Channel Vision's single-source and multi-source CAT5 audio systems. It provides convenient volume control and source selection capabilities, while its elegant decorator styling blends seamlessly with other wall switch devices.

**Features:**

- Compatible with all Channel Vision CAT5 audio systems
- Supports IR control: compatible with the A0505 remote control
- LEDs show volume level or source selection

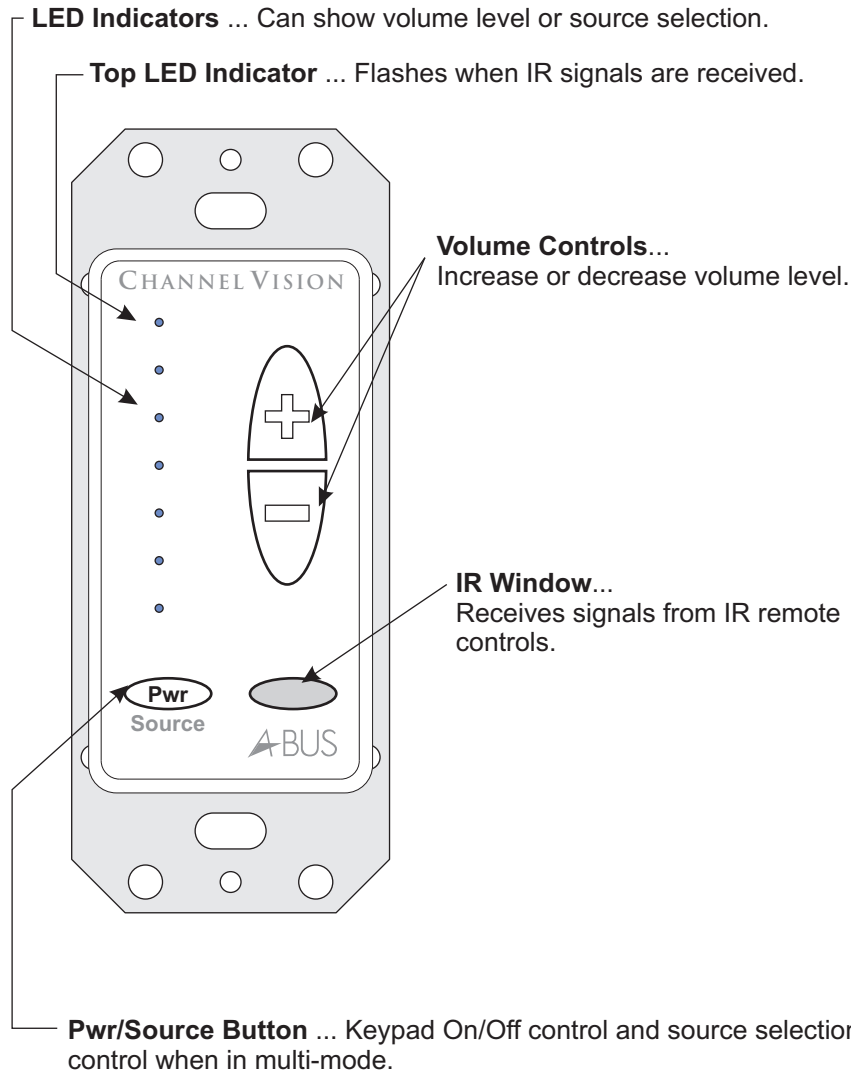

## Stripping and Connecting CAT5 Wire

CAT5 cable should be stripped with a proper stripping tool, such as Channel Vision's J-110 tool.

1. Place the CAT5 between the blade and the first notch of the J-110 tool.

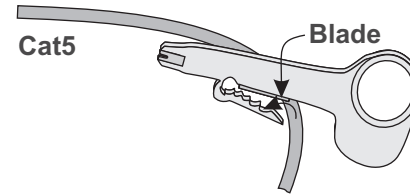

2. Rotate the tool only once. Multiple turns will cause you to cut into the inner wires.

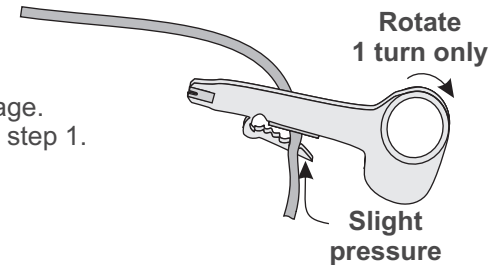

3. Inspect the inner wires for damage. If any wires are cut start over at step 1.

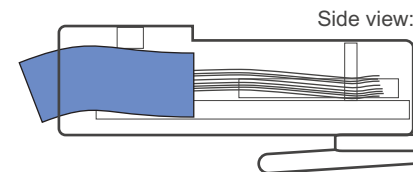

**TIA-568A RJ-45 Modular Plug**

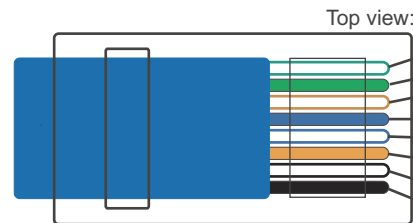

- Green/White - Left Channel Audio Ground
- Green - Left Channel Audio
- Orange/White - Right Channel Audio Ground
- Blue - IR Signal Voltage
- Blue/White - IR Status Voltage
- Orange - Right Channel Audio
- Brown/White - Ground (24vDC Ground)
- Brown - 24vDC

**Specifications:** (typical @25° C)

<b>Operating Voltage :</b>	24VDC 2.3 Amps
<b>Cable requirements:</b>	CAT5 or better
<b>Speaker impedance:</b>	6-8 ohm
<b>IR repeating:</b>	30-60kHz
<b>IR sensor range:</b>	40'@40kHz, 25'@56kHz
<b>Operating Temperature:</b>	-10°C to +50°C

Specifications subject to change without notice.

## Connection Tips and Troubleshooting

- 1) Verify you have connected the CAT5 cable correctly. Follow the TIA-568A standard at both ends. Mis-wiring can cause distorted sound, prevent the system from functioning, or possibly cause damage to the components in the system.
- 2) Verify you have connected the speakers in phase. Follow the label on the product. Out of phase speakers can rob the system of its bass, especially when driving dual-voice-coil speakers.
- 3) Trouble with IR control?
  - a. Verify you are using the correct remote control. The AB-134 will respond to IR signals from the A0505. The A0505 can provide both volume control and source selection commands. Other 3rd party remote controls that are capable of learning the IR codes from the A0505 can also be used.
  - b. The top LED on the AB-134 acts as an IR receiver feedback LED that flashes whenever IR signals are received. Check to make sure the LED flashes whenever you press buttons on your remote control. If you don't see the feedback LED, try replacing the batteries in your remote control.
  - c. Make sure your IR emitters are placed directly over the sensor on the device you are trying to control.
- 4) If no audio is heard, check to make sure that the audio source is playing, then press the power button on the AB-134 to make sure it is turned on.
  - a. Note, if the status jumper is on pins 1 & 2, the AB-134 will turn off if there is no audio present for more than 2 minutes. For most applications, it will be desirable to place the status jumper on pins 2 & 3 so that the AB-134 will revert back to its previous condition (either on or off) when music is played after a long pause.
  - b. Check power supply and voltage. Each Abus hub is powered by 24vDC. The solid brown wire is +, and the striped brown wire is -. If proper voltage is not fed to each amplified keypad, the system will not function normally.
- 5) Observe wiring distance specifications. The maximum recommended wire length between the audio hub output and AB-134 is 150 feet. Although the AB-134 can work at greater distances, such extreme distances are not recommended because erratic performance may result due to the power loss caused by the CAT5 wire. Locally powering the keypad may be an option.
- 6) If you need additional help troubleshooting the AB-134 please contact Channel Vision technical support (1-714-424-6500) or check our website for more details: [www.channelvision.com](http://www.channelvision.com).

## Compatibility

The AB-134 adheres to the same protocols as Channel Vision's other CAT5 audio hubs to ensure maximum compatibility. However, when using the AB-134 in a multi-source system, we recommend using Channel Vision's multi-source CAT5 audio matrix (model P-1044). Multi-source CAT5 audio products from other manufacturers may not (and typically will not) use the same control codes for advanced features such as source selection from the keypad.

## How it Works

The AB-134 can be used in two different modes: 1) single source mode, 2) multi-source mode. Mode selection is controlled by a jumper setting prior to installation. When using the AB-134 with a single-source CAT5 audio hub, it should be set for the single-source mode. In this mode, the unit provides basic controls: volume up, volume down, and power on/off. When using it with a multi-source CAT5 audio matrix, it should be set for multi-source mode. In this mode, any zone can independently select and listen to any source at any time. Source selection can be done either from the AB-134 amplified keypad or by using the A0505 remote control.

## Basic Operation

### Using the AB-134 Amplified keypad...

The Pwr (power) button located at the lower left of the keypad is used for source selection and to turn the unit on or off. When in single-source mode, press and release the Pwr button to toggle the keypad on or off. When in multi-source mode, if the keypad is off, press and release Pwr to turn it on. Press Pwr again to see the current source selection and press repeatedly to scroll through the 4 sources. Press and hold the power button to turn the keypad off. While the keypad is off, press and hold the power button again to turn off the zone output of the P-1044.

As you change sources when in multi-mode, you'll notice that the top 4 LEDs illuminate corresponding to the source you have selected. When source one is selected, the first LED is illuminated, when source two is selected, the second LED is illuminated, and so on.

After a source is selected the LED will stay lit for 5 seconds, then it will return to showing the current volume level.

Volume adjustments can be made using the up/down buttons to the right hand side of the keypad. The keypad can be controlled from the A0505 remote control (see the section titled: Using the A0505 remote control for more details).

- These four LEDs illuminate to indicate which source input is selected.
- The Pwr button is used for source selection.

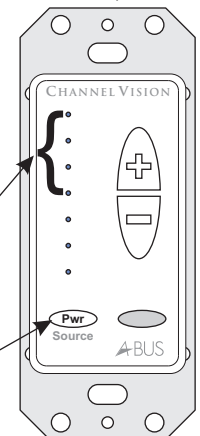

## Jumper Settings

Jumper settings determine how the AB-134 will react under various circumstances. These jumpers should be set to the desired configuration before the AB-134 is installed. If you need to make changes to the jumper settings, the AB-134 MUST BE DISCONNECTED from the system first.

### Jumper setting functions explained:

**Volume Preset** - This jumper sets the starting volume of the keypad will be when it is turned on. If the jumper is on pins 1 & 2, the volume will always be set at the default level when the AB-134 is turned on. If the jumper is on pins 2 & 3, the volume will be at the same level as it was before the AB-134 was turned off.

**Status** is active when the zone is on and audio is present. Status will go dormant when audio is not present at the source.

**Status Active** - This jumper determines what happens when the status becomes active. Typically, when status becomes dormant, Channel Vision amplified keypads go into a 'sleep' mode which mutes the amplified keypad. If the jumper is on pins 1 & 2 when status becomes active, the AB-134 will remain off until the power button is pressed. If the jumper is on pins 2 & 3 when the status becomes active, the AB-134 will return to its previous state (either on or off).

**Source Mode** - This jumper determines if the AB-134 will be used as a multi-source keypad or a single-source keypad. If you are using the keypad in a single source system, set the jumper on pins 1 & 2. If you are using the keypad in a multi-source system, set the jumper on pins 2 & 3.

Jumper Function	Jumper on Pins 1 & 2	Jumper on Pins 2 & 3
Volume Level	Default volume level	Previous volume level
Status Active	Off until Pwr is pressed	Previous state
Source Mode	Single-Source	Multi-Source

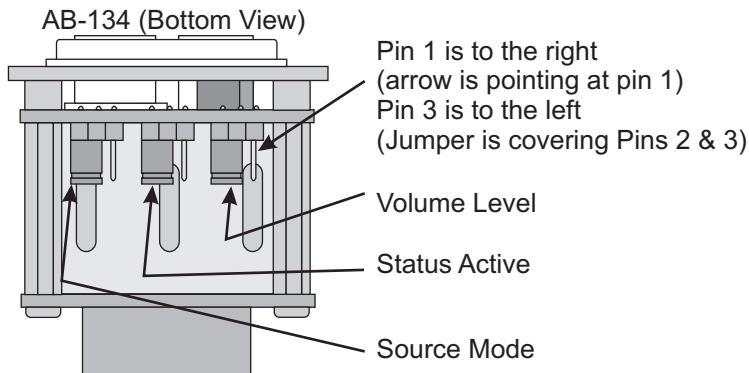

## Adding more power

### Using the A0240 with the A0302

The A0302 is the perfect complement to Channel Vision's A0240 amplifier. It can utilize the Amp-Link connection, which provides a clean way to interrupt the speaker-level audio from a low-power system and output 40 Watts per channel to the speakers. This is the perfect way to add power to low-power distributed audio systems.

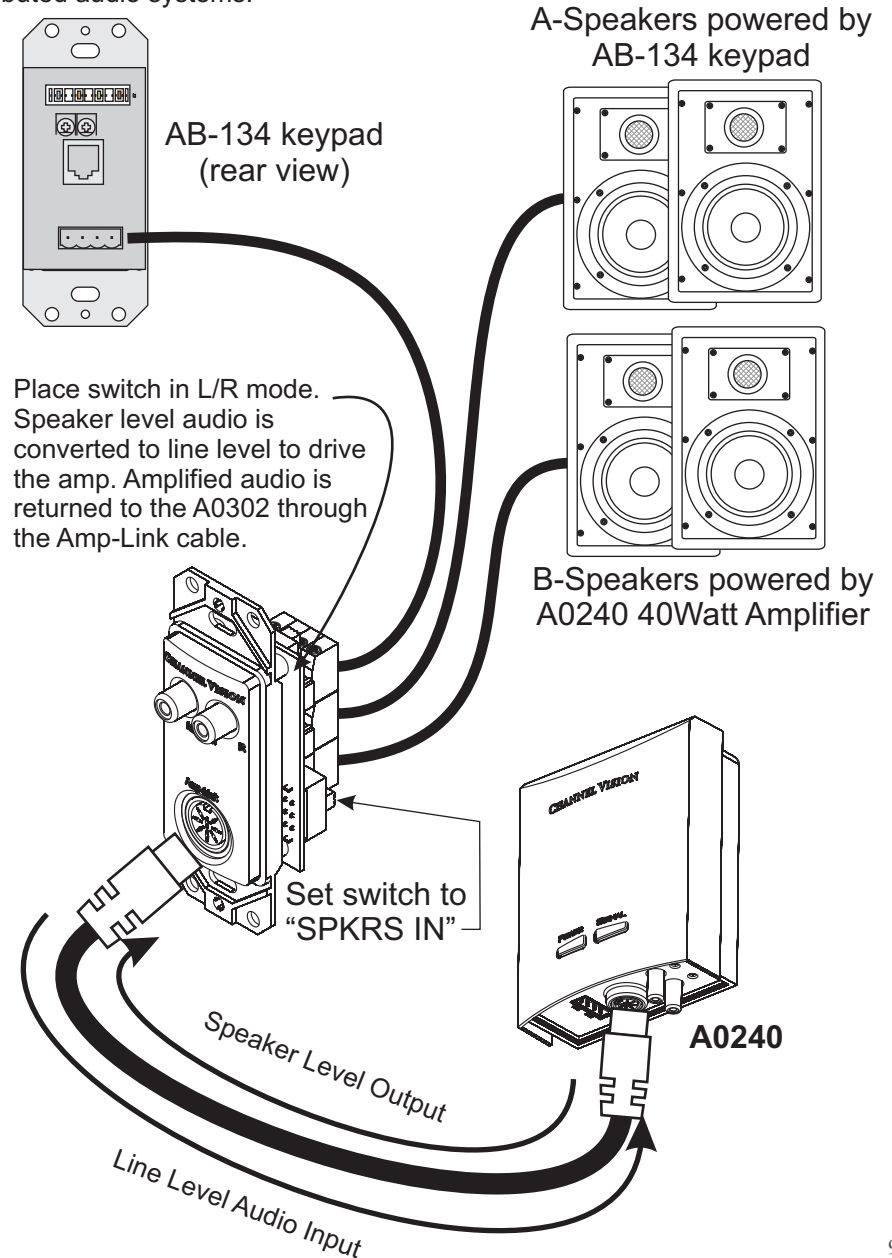

## Using The A0505 remote control

The A0505 is designed to allow you to control your P-1044 without having to touch the buttons on the AB-134. Simply point the A0505 remote control at the IR sensor located at the bottom of the AB-134 and press the desired button.

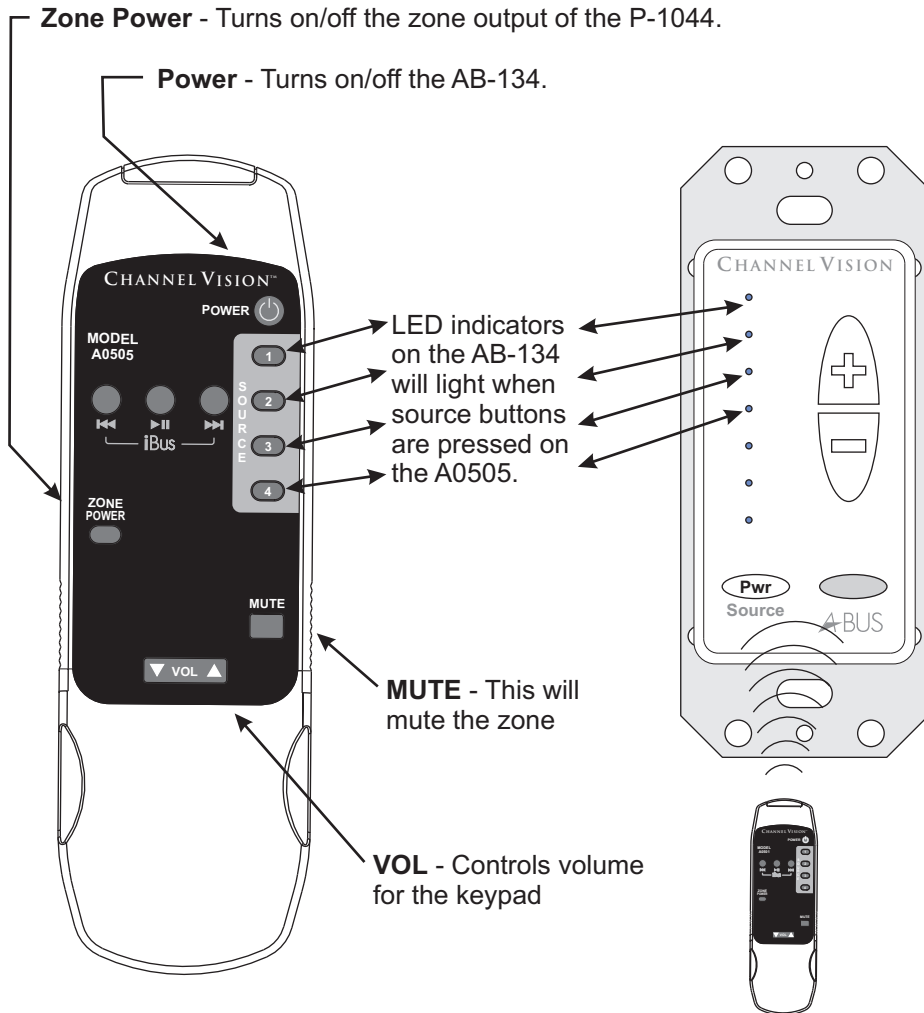

### Downloading IR commands...

If you don't have access to the A0505 remote and you need to program a learning remote, you can download the IR codes from the internet. IR codes compatible with the Philips Pronto remote controls can be downloaded from the following websites:

- [www.channelvision.com](http://www.channelvision.com) (codes in Hex format)
- [www.remotecentral.com](http://www.remotecentral.com) (codes in Pronto format)

## Installation

AB-134 (Rear View)

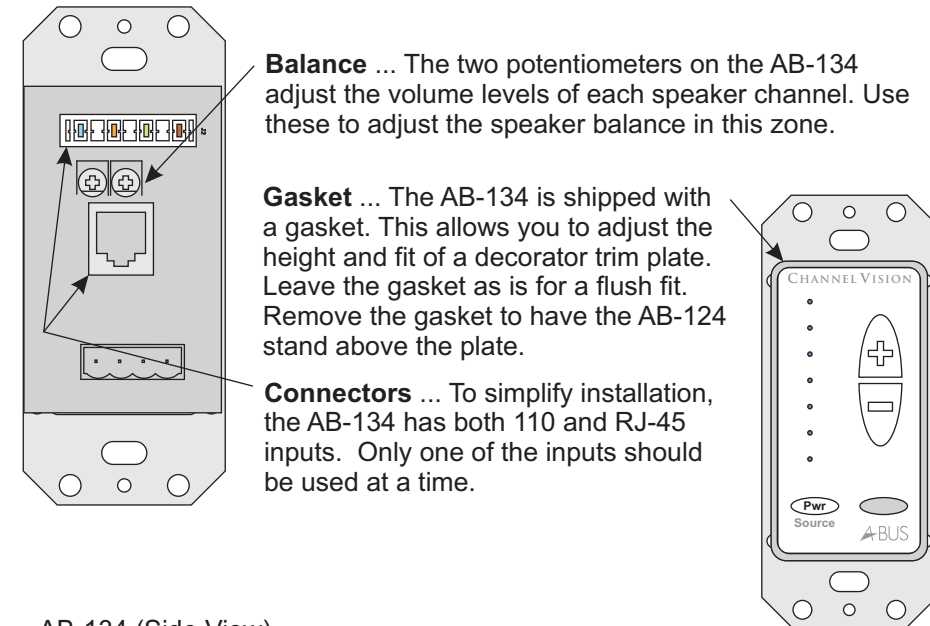

AB-134 (Side View)

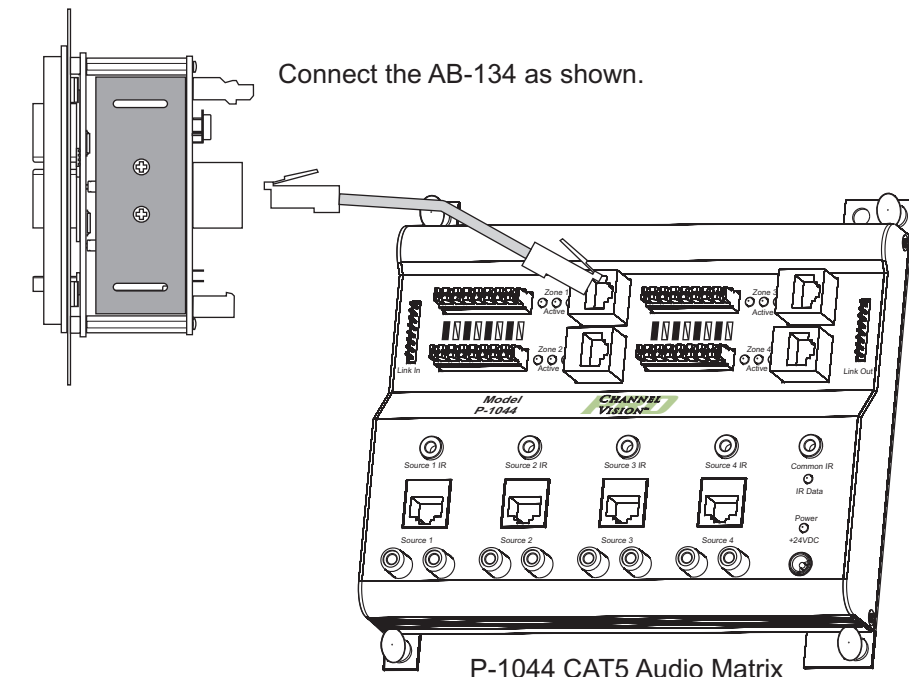

## Single-Source System

When using the AB-134 with single-source CAT5 audio hubs, the source mode jumper should be set for single-source. In this mode, the source selection features are not available. Pressing the PWR button will turn off the keypad, but other keypads will continue to play.

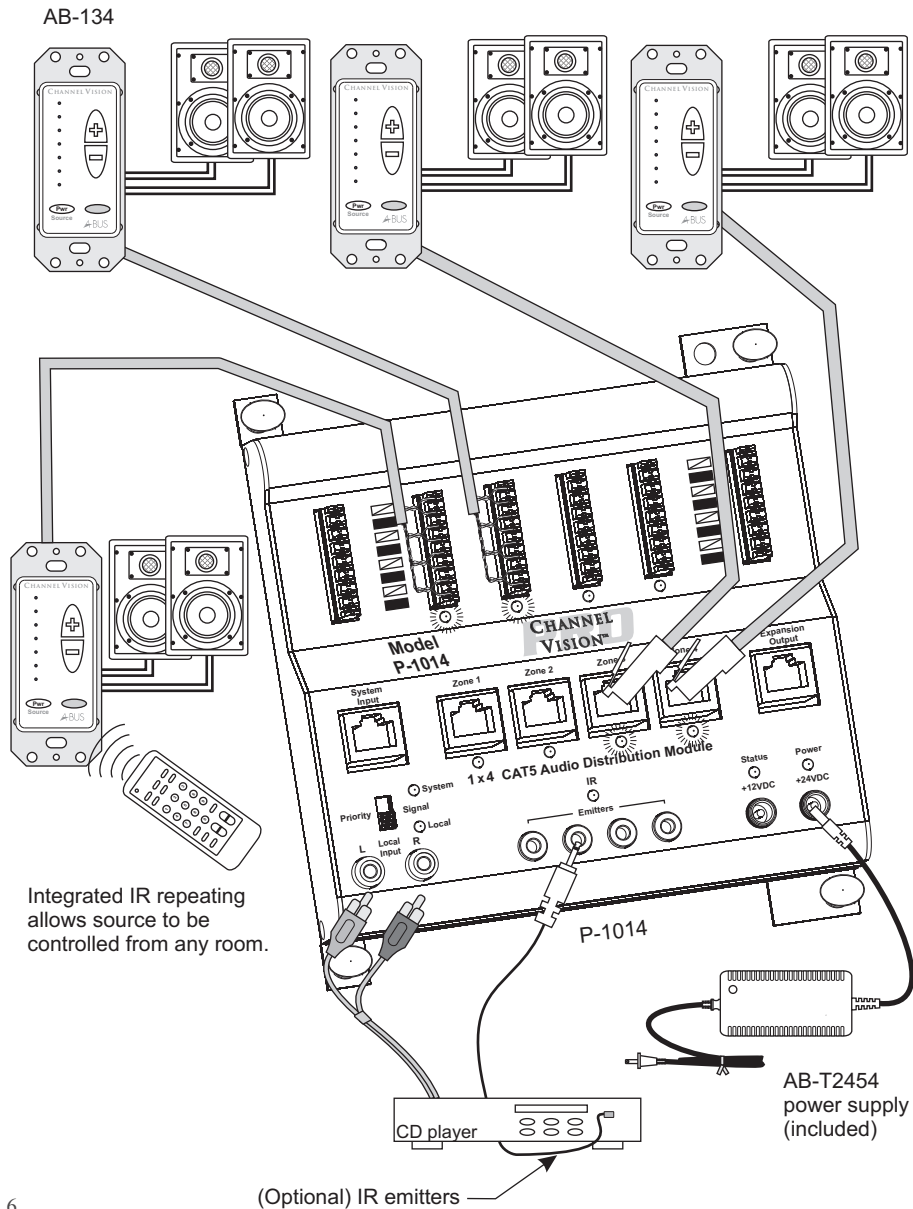

## Multi-Source Application

When using the AB-134 in a multi-source system with the P-1044, the source mode jumper should be set for multi-source. In this mode, the source selection features are enabled allowing any zone to independently select and listen to any source at any time.

